











60 min

| | | | | | |
|--|---|--|--|--|---|
| Ax40  | Bx40  | Cx56  | Dx4  7x50 | Ex16  | Fx4  |
| Gx8  M4x22 | Hx16  Ø4x35 | Ix4  | Jx50  1,2x20 | Kx1  | |
| Lx4  | Mx4  | | | | |



2-5

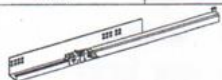
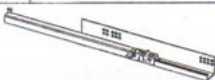
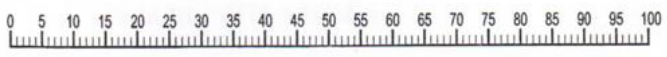
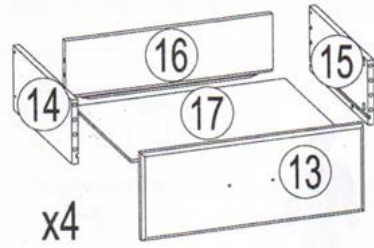
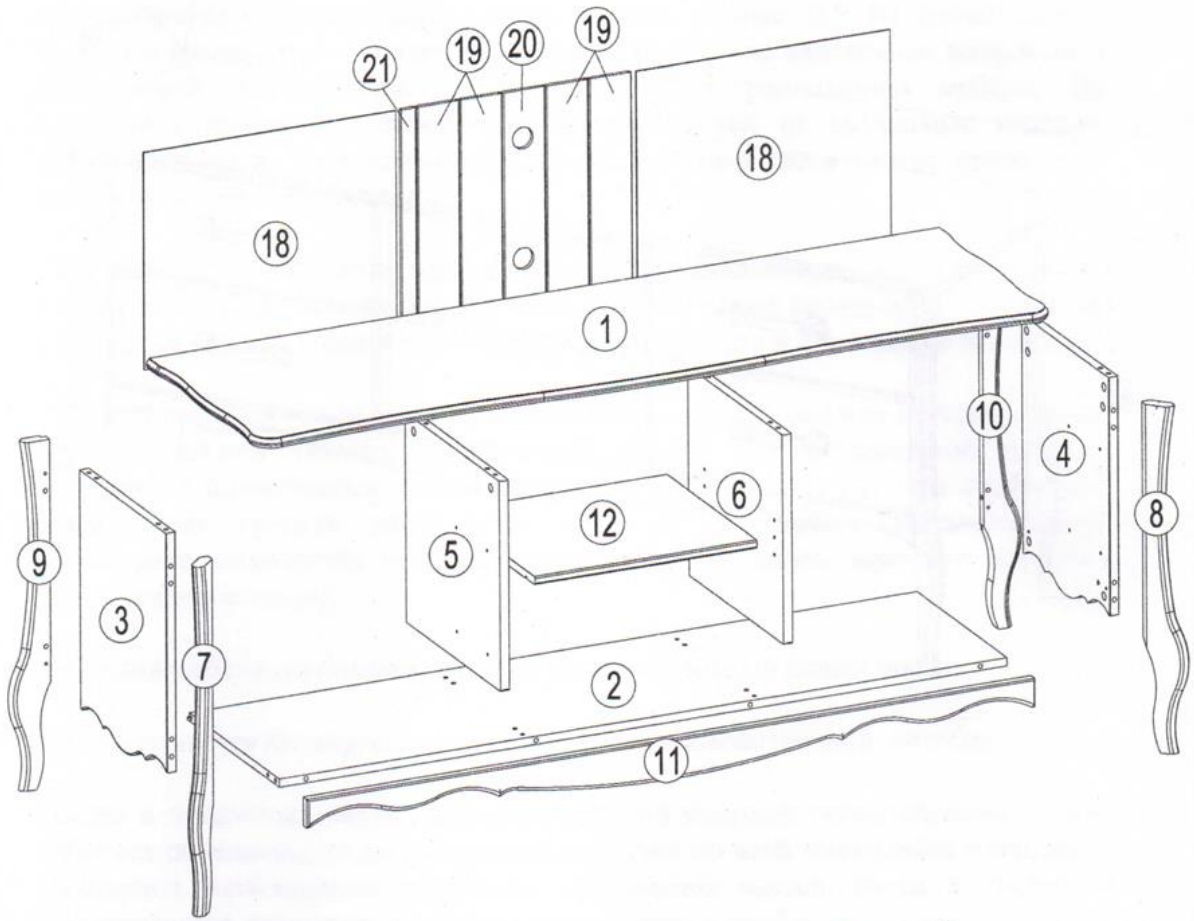

1

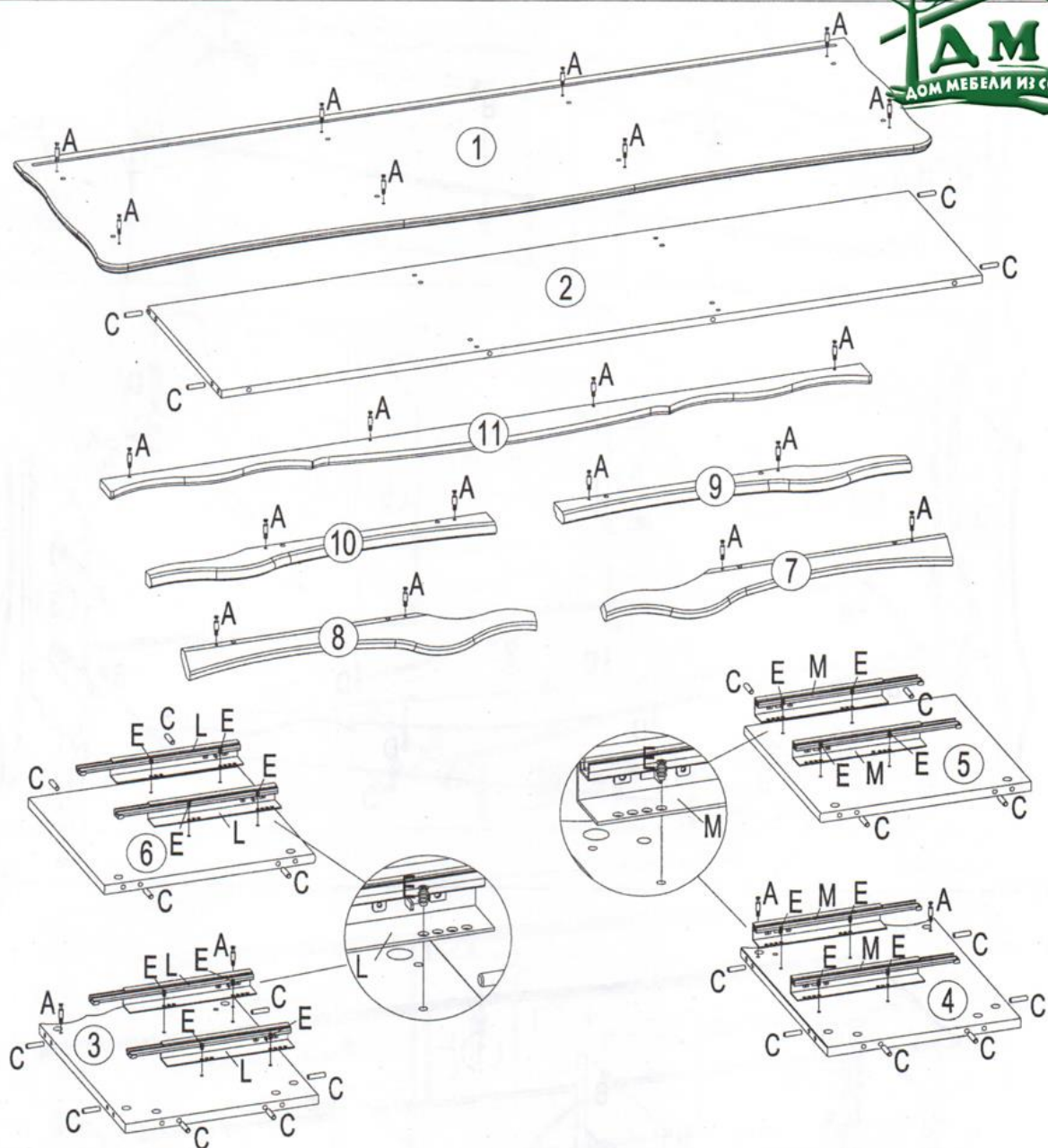

2

